



Maxitronix™

ELECTRONIC LAB

**ELECTRONIC
SHORT WAVE**

OWNER'S MANUAL
RADIO
KIT

Safe, Solderless, Exciting, Educational and Fun!
Easy-To-Read Illustrated
Operating Manual Included!

- Learn and Build your own SHORT WAVE RADIO!
- Explore the World of SHORT WAVE RADIOS!
- Receives band from 6-8 MHz (SW 1)
& 12-18 MHz (SW 2)!
- Learn how RADIOS work!
- With earphone included!
- Uses one 9V battery! (not included)

ITEM NO. MK-901SW
For ages 8 and up

TABLE OF CONTENTS

● TOOLS REQUIRED	4
● GETTING STARTED	4
● PARTS LIST – SYMBOLS & DRAWINGS	5
Electrical Parts	5
Mechanical Parts	6
● ASSEMBLY INSTRUCTIONS	9
Spring Terminals	9
Resistors	9
Capacitors	10
Transistors	11
● Bar Antenna	12
● SW Tuner Board	12 ~13
● Tuning Capacitor	13
● Battery and Battery Snap	14
● Wiring	15
● AM SW RADIO CIRCUIT DIAGRAM	17
● MASTER PARTS LIST	18

Copyright All Rights Reserved/2000 Maxitronix Enterprise Limited

This AM-SW Radio is an excellent kit to help you begin your study of electronics. It's so simple, you'll spend only a couple of hours putting it together. No soldering is required and you can make circuit changes very easily.

The MX-901S AM-SW Radio Kit uses one transistor, 4 resistors and 5 capacitors including a variable capacitor. It has high sensitivity and covers a frequency range from 6MHz to 8MHz for SW, and from 12MHz to 18MHz for SW2.

In these Short Wave bands, you can enjoy listening to the Voice of America, BBC, Radio Moscow, Radio Nederland and many other international stations.

This manual contains easy-to-follow, step-by-step instructions with drawings for clarity.

The broadcast signal coming to the antenna is tuned in or selected by the coil and variable capacitor circuit. The one-transistor amplifier circuit then increases the signal strength.

The broadcast signal consists of high-frequency (radio frequency) waves modulated with low-frequency (audio frequency) waves.

The Short Wave tuner circuit is on the small Printed Circuit Board. The radio signal input terminals are 9 and 10.

The audio amplifier circuit lies between terminals 11, 13 and 16. This circuit increases the audio frequency signal to levels capable of driving the earphone.

You will only need a few simple tools to build your kit.

- * Small screwdriver
- * A pair of long-nose pliers
- * Wire cutters

You will also need one 9V battery. TYPE 1604G or 6F22.

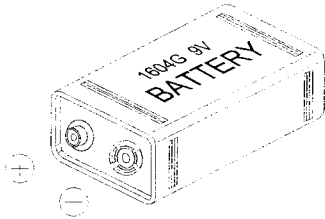

The first thing good kit builders do with a new project is to make sure all the necessary parts are in their kit.

To do this, check the contents of your kit against the parts list. The parts list is separated into two sections, electrical items (resistor, transistors and so forth) and mechanical parts (nuts, spring, screws, wires etc.). As you check off the parts, put them in a safe place so they will not get lost or damaged. Keeping them in the lid of the kit box is a good idea.

Next to each electronic part, you will see a picture of the part as well as its "schematic symbol". The schematic symbol will help you identify the part and locate the correct position for the part on the kit's cardboard panel. The quantity provided is in parenthesis.

4

ELECTRICAL PARTS

- Bar Antenna (1) – This is a ferrite rod



- Antenna coil (2) one for SW1 and the other for SW2.

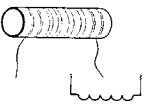

- Capacitor (4) – There are two kinds of capacitors in your kit: electrolytic and ceramic. The electrolytic capacitors look like tiny tin cans.

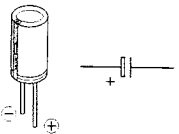

10uF(1) marked 10uF/25V

The ceramic capacitors are small, flat and circular. Each is marked with its value.

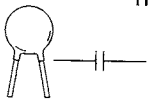

- 100pF (1) 100pf or 101
- 470pF (1) 470pF or 471
- 0.1uF (1) 0.1uF or 104

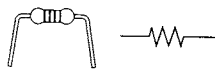

- Resistors (4) – These are the Small, tan tubular objects with colored stripes. The stripes are used to identify their electrical values.

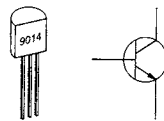

- Transistors (1) – Transistors have three leads instead of two like the other electronic parts you have seen. Possible markings are C945, C1815, 9013, or 9014.

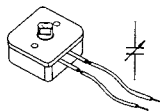

- Variable Capacitors (1) this capacitor is used to tune the Bar Antenna to the desired frequency of the signal you want to receive.

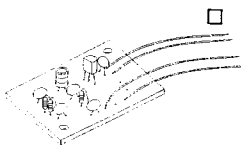

- Tuner Assembly for SW (1) – The SW tuner is assembled on the small Printed Circuit Board at the factory.

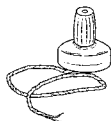

- Earphone, Ceramic (1) – This small earphone changes electrical energy to sound waves that you hear.

MECHANICAL PARTS

- Cardboard Panel with Plastic Frame. (1)

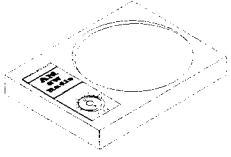

- Tuning Knob for SW (1)

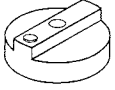

- Battery Snap for 9V Battery (1)



- Spring Terminals (18)



- Antenna Holder (polypropylene) for mounting (2)

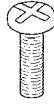

- Screws:
Long Type M3.0x8 (2)



- Small Type M2.6x4 (3)

- Nut (2)



- Wire: (11)

White, (3") 75mm (8)

Blue, (5") 130mm (2)

Green, for antenna (10') 3m (1)

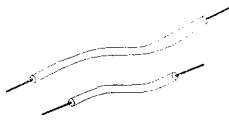

6

Refer to the following illustrations of complete unit when you are building the kit:

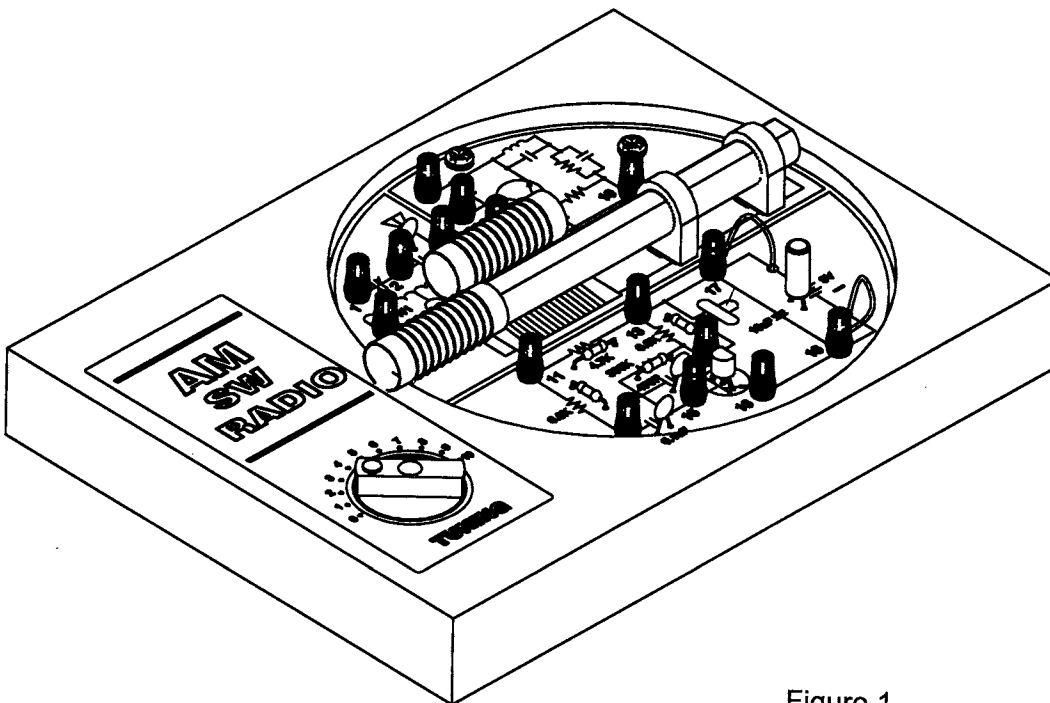

Figure 1

Refer to the following illustration of complete unit when you building the kit:

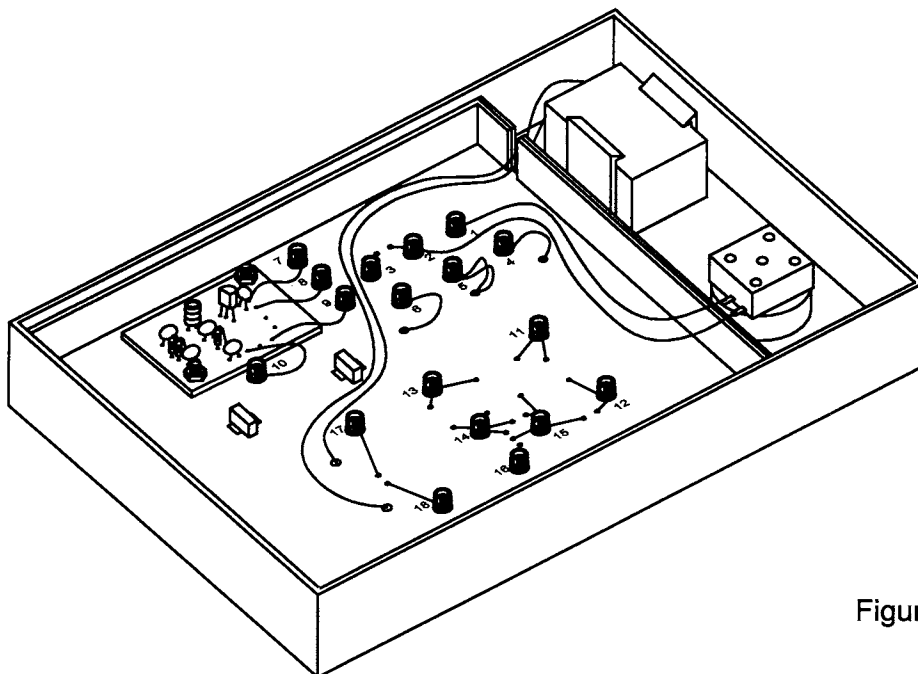

Figure 2

8

ASSEMBLY INSTALLATION

SPRING TERMINALS

The spring terminals provide an easy way to make electrical connections without the use of solder.

- From the top side of the cardboard panel, install 18 spring terminals into the 18 large, numbered holes; To make installation easier, use the pointed end of a pencil or ballpoint pen to push the spring through the holes and twist slightly. (See Figure 3.)

You will make many of your connections on the back side of the cardboard panel. As you install each spring, mark the number of each terminal on the backside of the panel.

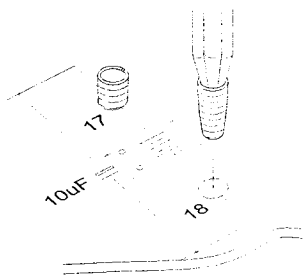

Figure 3

RESISTORS

Mount the 4.7k ohm resistor first. (yellow, purple, red, gold)

- Mount the resistor by bending its leads and inserting them, from the top of the cardboard panel, through the holes next to schematic symbol. (See Figure 4.)
- Now turn the panel over and connect the leads to 11 and 13. Simply bend the spring to one side with the long-nose pliers or your finger and insert the wire between the coils of the spring. The first connections are always the hardest, but you will soon learn to do this easily.

Remember that you will identify the resistors by their colored bands.

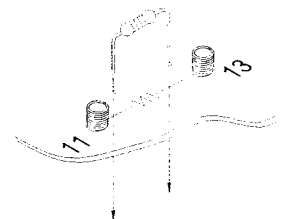

Figure 4

- Connect the 390K ohm resistor (orange, white, yellow, and gold) to terminals 15 and 14.
- Connect one 6.8K ohm resistor (blue, gray red, gold) to terminals 11 and 12.
- Connect the other 6.8K ohm resistor (blue, gray, red, gold) to terminals 13 and 14.

CAPACITORS

From the top of the cardboard panel, insert the two leads of each capacitor through the holes next to its schematic symbol. (See Figure 5.)

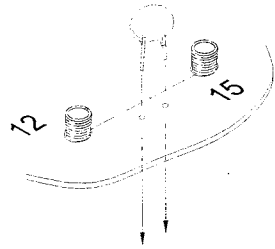

Figure 5

Then on the back side of the panel, connect the leads to the designated spring terminals.

10

Now go back and carefully check your work. Be sure you have positioned each part in the right place. Be sure the minus (-) side of the electrolytic capacitor is toward the proper terminal.

Double-check these parts. On the bottom side, cut off any excess wire ends.

TRANSISTORS

Each transistor has three leads. **Each lead must go into the correct hole in the Panel Board.** Pick up the Transistor and look at the bottom where the leads come out.

Now, look at the Transistor, with the flat side toward you as shown in Figure 7.

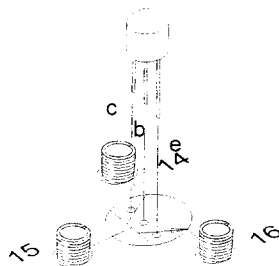

Figure 7

Make a mental note of the position of each lead, E, C and B. (See Figure 7.)

Mount the 0.1uF capacitor (large, marked 104) to the holes and connect its leads to 12 and 15.

- Mount the 100pF capacitor (small, marked 101) and connect its leads to 2 and 3.
- Mount the 470pF capacitor (small, marked 471) and connect its leads to 14 and 15.

The remaining capacitor is an electrolytic. This means it must be connected observing the proper polarity (+ and -). The side of the capacitor with the minus (-) lead is marked with a vertical strip and minus (-) sign. Of course, the other side is (+). (See Figure 6.)

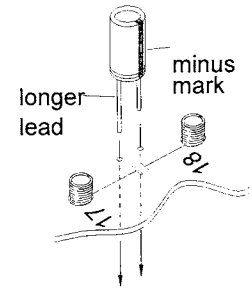

Figure 6

Connect the 10uF capacitors to terminals 17 (+) and 18 (-).

OK, got that? Now let's proceed.

- Mount a Transistor marked 9014 between 14, 15 and 16. **Position it so the flat side is away from spring 15.** Insert the leads through the holes provided. On the bottom, connect the upper lead to 14, the center lead to 15 and the lower lead to 16. (See Figure 7 and 8.)

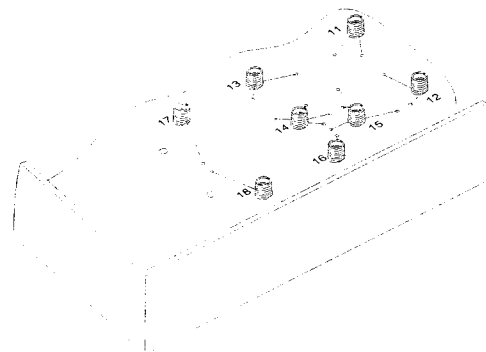

Figure 8

- Since the transistors are so important- and you must be sure you get them correctly installed. Double-check them to be certain that each lead goes into the correct hole and that you do not have the leads overlapping on bottom side.

BAR ANTENNA

Examine the antenna coils. They have some very thin wires coming from them. Handle them with care.

- Insert the Holders into the holes of the Board and rotate them to accommodate the coils
- Position the Coil as shown, inserting the leads down through the holes provided. (See Figure 9.)
- Slip the bar into the SW1 (gold) Coil and the holders. Don't mount the SW2 (red) Coil on the bar.
- Turn the Panel over and very carefully connect the wire from the Antenna Coil as shown:

Gold wire (SW1 Band) to terminal 4 and 5.
Red wire (SW2 Band) to terminal 5 and 6.

Note: be sure that you connect the tinned end to each spring. Do not let any wires cross each other.

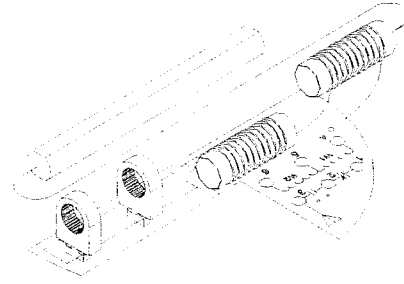

Figure 9

SW TUNER BOARD

You must use extreme care when you handle and mount the tuner - try not to touch any parts on the Board. Hold it only by the edges.

- Look at figure 10 & figure 2 when mounting the SW Tuner Assembly to the bottom of the Panel Board. Insert the two long screws from the top of the Panel.

12

- Turn the panel over and place the Tuner Board on the screws and tighten each nut with a screwdriver and long-nose pliers. Do not over tighten.
- There are four wires coming out of the Tuner assembly.
Connect the green wire to spring terminal 7. (See Figure 10)
Connect the blue wire to spring terminal 8.
Connect the yellow wire to spring terminal 9.
Connect the black wire to spring terminal 10.

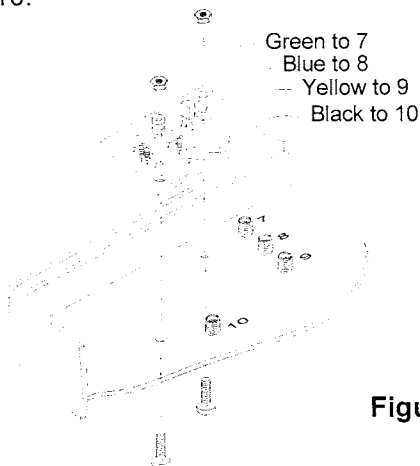

Figure 10

TUNING CAPACITOR

- Mount the tuning Capacitor from the bottom of the panel and position as shown on Figure 11.
- On the top, fasten it with two small screws.
- Place the Tuning Knob on the Tuning Capacitor shaft.
- Make sure the mark is at the left side of the shaft when you rotate the knob counter-clockwise.
- Fasten the knob with a small screw.

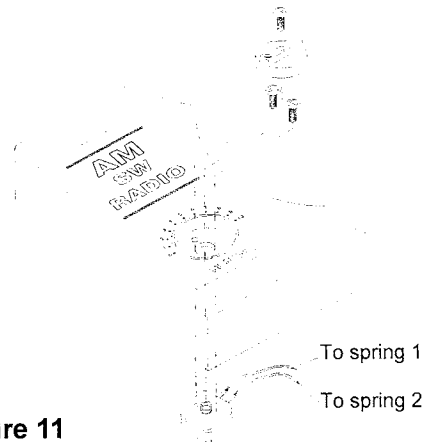

Figure 11

- Turn the Panel over and on the bottom, connect the Tuning Capacitor leads to terminals 1 and 2. (See Figure 2.)

This completes most of the wiring on the Panel Board. But, before you finish up, check your work once more:

BATTERY SNAP

Place a 9V battery in the battery slot. (See Figure 12)

- Connect the Red wire Of the Battery snap to terminal 17 and the Black wire to terminal 18.

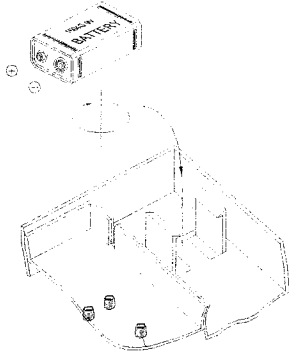
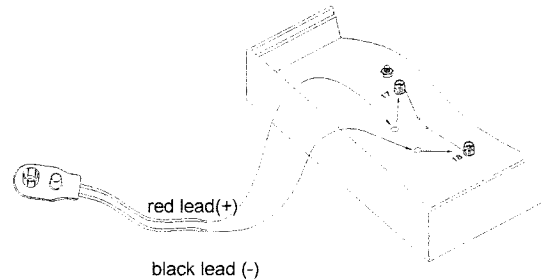

Figure 12

1. Be sure the transistor leads are connected properly. Study Figure 7 once more and be sure each lead goes where it should.
2. Place your Board next to Figure 1 and compare each part and its leads to the illustration.
3. Turn the Board upside down and compare your wire connections to Figure 2.
4. Cut off any remaining excess wire ends.



14

FINAL WIRING

REFER BACK TO FIGURE 1 and install the final wires on the top, as illustrated and noted below:

A) For both SW1 and SW2 wiring:

- Connect a White wire between 1 and 7.
- Connect a White wire between 2 and 8.
- Connect a White wire between 13 and 17.
- Connect a White wire between 16 and 18.
- Connect a Blue wire between 9 and 11.
- Connect a Blue wire between 10 and 18.

B) If you want the first short wave band (SW1), connect the following wires:

- Connect a White wire between 5 and 8.
- Connect a White wire between 4 and 9.

C) If you want the SW2 Band to work, connect the following wires:

- Connect a White wire between 5 and 8.
- Connect a White wire between 6 and 9.

- Connect the Earphone leads to terminal 13 and 14.
- Snap the 9V Battery to the battery snap (Be sure to install the battery with the correct polarity)

Your AM SW Radio is now ready to use.

Place the Earphone in your ear and adjust the tuning knob to hear the desired SW signal.

For SW reception, you should connect an external or outdoor antenna.

For best Radio reception, you should connect wire as follows:

Connect the green wires to terminal 3. Then extend the other end out a window or attach it to the metal around a sliding door or to wire-type window screen.

Or, you can connect this terminal to an outside antenna.

Note: To turn the Radio off, merely remove the battery.

TROUBLE SHOOTING GUIDE

1. Make sure the 9V battery has been installed correctly.
2. Try new batteries. If the Batteries are weak or dead, your Radio won't work.
3. Go back through this manual and check each step again. A good way to do this is with a colored pencil and mark on the illustrations your wiring. Then check to see if there are any mistakes.
4. Check your wired unit against Figure 1 and Figure 2.
5. Be especially careful as you check the wiring of the Transistors and the electrolytic Capacitors. Check all illustrations and diagrams carefully.
6. It's always a good idea to have a friend double check your work. You might be overlooking the same mistake time and again. Have a friend compare your Panel (with all parts mounted on it) with Figures 1 and 2.
7. When noise is a problem in SW1 reception, make sure that the SW1 antenna coil is flush with the left end of the antenna rod.

16

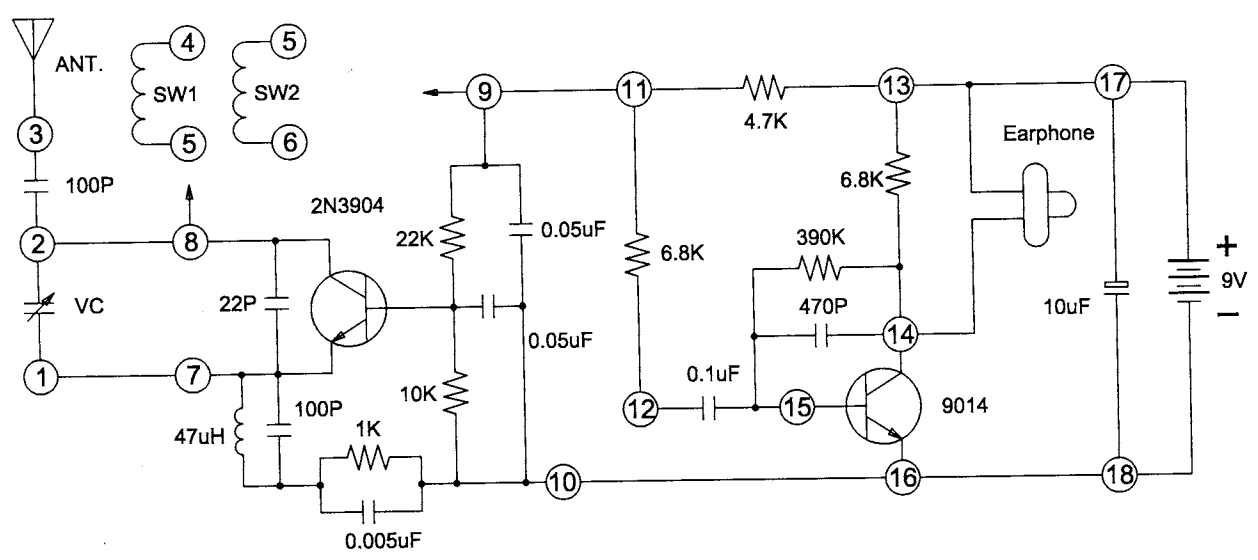

AM SW RADIO SCHEMATIC DIAGRAM

MASTER PARTS LIST

Description	Description
Antenna Coils(2) Bar Antenna (1) Capacitors: 10uF 25V or 50V electrolytic (1) 100pF ceramic disc (1) 470pF ceramic disc (1) 0.1uF ceramic disc (1) Resistors: 4.7K ohm (yellow, purple, red, gold) (1) 6.8K ohm (blue, gray, red, gold) (2) 390k ohm (orange, white, yellow, gold) (1) Transistors 2SC1815 or 9013 or 9014 (1) Tuning Capacitor (1) Earphone, ceramic (1) Tuner Assembly for SW (1)	Holders for Bar Antenna (2) Knob for tuning (1) Cardboard Panel with plastic Frame (1) Nuts (2) Screws: Long Type M3.0x8 (2) Short Type M2.6x4 (3) Snap for 9V Battery (1) Spring, Terminals (18) Wires, for Hook up White (3") 75mm (8) Blue (5") 130mm (2) Green (10') 3m (1)